

LCM-25/40/60KN LED Driver with KNX Interface Instruction Manual

Content

1.Overview	1
1.1 Overview devices	1
1.2 Usage & possible applications	1
1.3 Displays and operating elements	1
1.4 Circuit diagrams	2
1.5 Wiring	4
1.6 Information at the ETS-Software	4
1.7 Starting up	4
2.Communication Objects	4
2.1 Summary and Usage	4
3.Reference ETS-Parameter	6
3.1 General function	6
3.2 Handling/ basic functions	7
3.3 Time functions	7
3.4 Staircase light	8
3.5 Push dim port	10
3.6 Operating hours & Constant light output (CLO)	13
3.7 Absolute Values	13
3.8 Specific Dimming settings	14
3.9 Scene function	16
3.10 Automatic function	17
3.11 Block function	18
3.12 Other useful information	20
4.Environmental declaration information	20
Appendix	21
A.1 LCM-KN Series Application/Firmware change tracking	21

1. Overview

1.1 Overview devices

The manual refers to the following devices: (Order Code respectively printed in bold type):

- LCM-25KN: INPUT: 180 ~ 295VAC 47 ~ 63Hz, OUTPUT: 350mA ~ 1050mA, 6 ~ 54V
- LCM-40KN: INPUT: 180 ~ 295VAC 47 ~ 63Hz, OUTPUT: 350mA ~ 1050mA, 2 ~ 100V
- LCM-60KN: INPUT: 180 ~ 295VAC 47 ~ 63Hz, OUTPUT: 500mA ~ 1400mA, 2 ~ 90V

1.2 Usage & possible applications

The LCM KN series is a constant current mode output LED driver featuring the multiple levels selectable by dip switch and the KNX interface to avoid using the complicated KNX-DALI gateway. There are a great number of options for adjusting the dimming process, e.g. dimming speeds, transition time, On-/Off- Behavior.... Scene function and different automatic functions are also available for the KNX interface. In addition, the LED drivers are equipped with push dimming and synchronization so as to provide the optimal design flexibility for LED lighting system.

1.3 Displays and operating elements

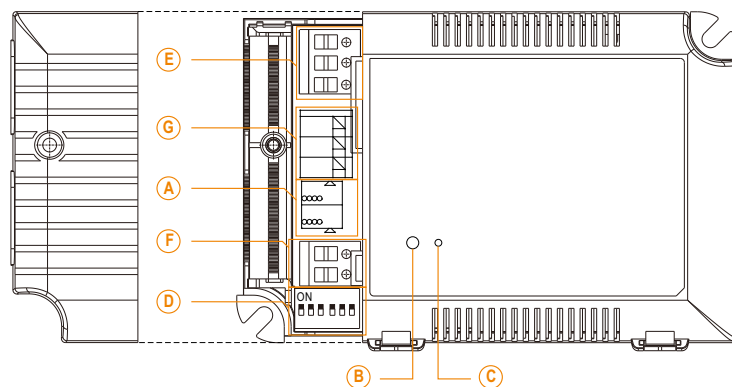

- Ⓐ : KNX Bus connection terminal
- Ⓑ : Programming button
- Ⓒ : Programming LED
- Ⓓ : DIP switch for adjusting output current
- Ⓔ : AC input + push dim signal input
- Ⓕ : DC output
- Ⓖ : Peripherals for AUX DC output(optional), LED NTC compensation and synchronization signal

1.4 Circuit diagrams

Configuration 1: General use

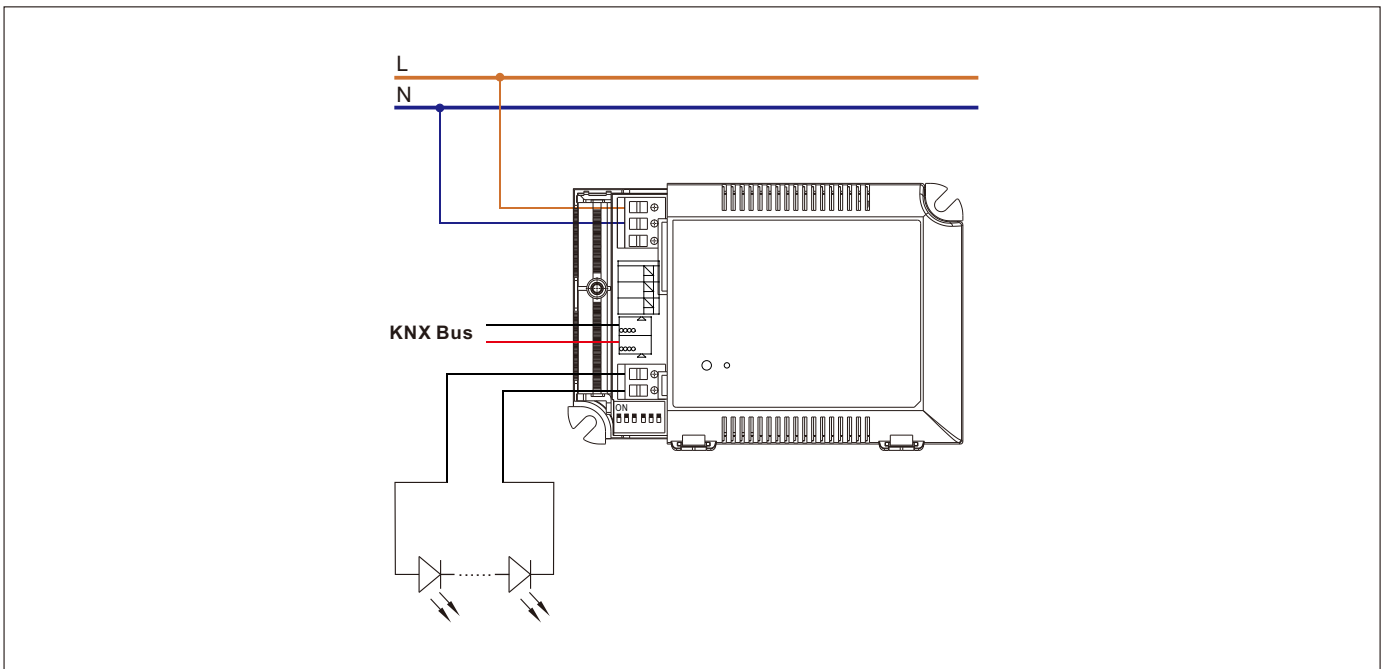

Configuration 2: With push dimming

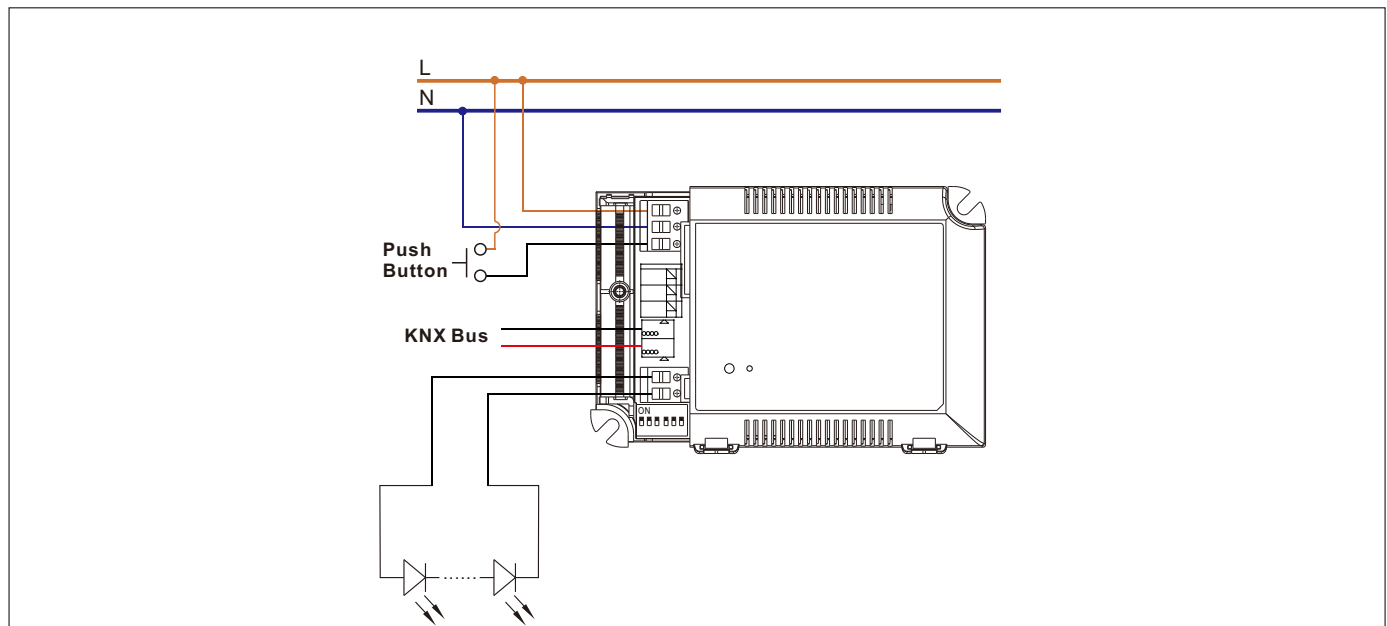

- KNX bus need to be connected when using PUSH Dimming.
- The detailed function of PUSH dimming, please refer to 3.5 Push dim port.
- The maximum length of the cable between the push button and driver is 20 meters.
- The mechanical push button can be connected only between the PUSH terminal, as displayed in the diagram, and AC/L (in brown or black); it will lead to short circuit if it is connected to AC/N.
- In case the PUSH dimming is set locally, up to 10 drivers can perform the PUSH dimming at the same time when utilizing one common push button.
- In case the PUSH dimming is set independently via ETS, the number of drivers is done through group address and determined by the ETS project designer.

Configuration 3: With AC/DC input monitor

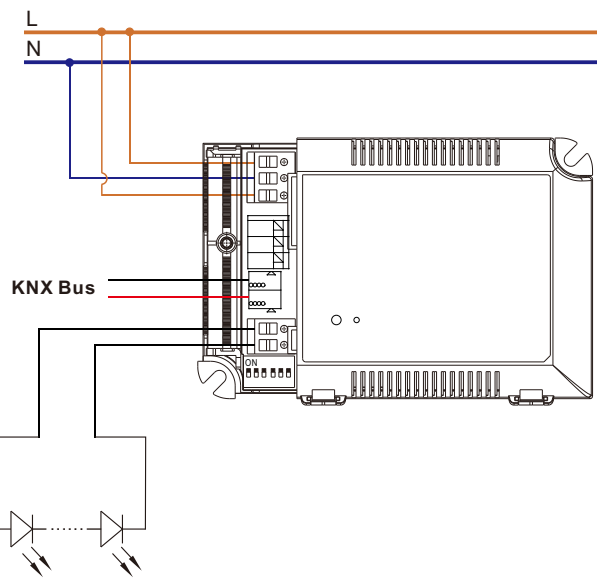

- KNX bus need to be connected when using AC/DC input monitor.
- The detailed function of AC/DC input monitor(emergency lighting), please refer to 3.5 Push dim port.

Configuration 4: Synchronization operation

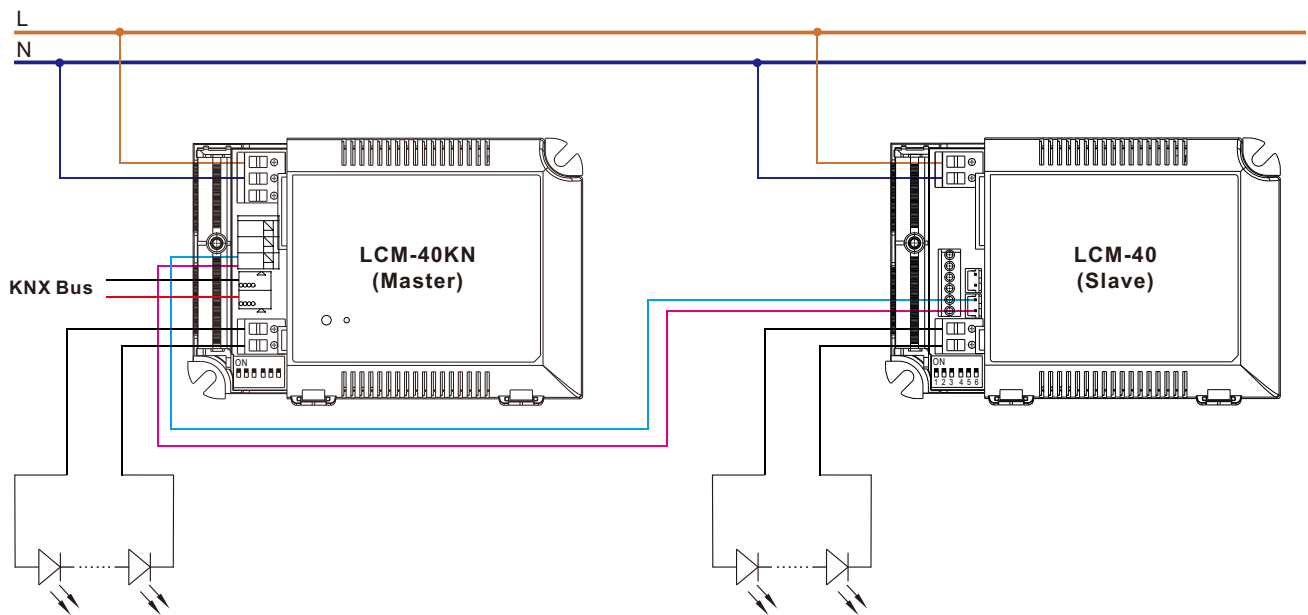

- Synchronization up to 10 drivers (1 master + 9 slaves, the master is LCM-KN and the slaves are LCM standard model)
- Dimming operating range : 6%~100%
- Sync cable length : < 5m
- Sync cable type : Flat cable
- Sync cable cross section area : 22 – 24 AWG (0.2~0.3mm²)

1.5 Wiring

- Use wires with an adequate cross-section.
- Use suitable mounting tools to do the wiring and mounting.
- The maximum number of bus devices connected is 256.
- The maximum length of a line segment is 350 m, measured along the line between the power supply and the furthest bus device.
- The maximum distance between two bus devices cannot exceed 700 m.
- The maximum length of a bus line is 1000 m, keeping into account all segments.

LCM-40/60KN

Type	The cover (the blue one)	Push terminal 1 (AC/L, AC/N, Push, Vo±)	Push terminal 2 (NTC±, SYN±, FAN±)	KNX bus terminal (BUS V±)
Solid wire	-----	-----	-----	0.6 ~ 0.8Φ
Stranded wire	-----	0.823 ~ 2.08mm ²	0.129 ~ 0.326mm ²	-----
American wire gauge	-----	14 ~ 18AWG	22 ~ 26AWG	20 ~ 22AWG
Wire stripping length	-----	10mm (0.39")	7mm (0.27")	5mm (0.196")
Screwdriver	6mm Phillips	3mm Phillips	3mm Phillips	-----
Recommended tightening torque	4.6 kgf-cm (4 lb-in)	-----	-----	-----
Suggested push-down strength	-----	3 ~ 4kg (6.61 ~ 8.81 lbF)	0.5 ~ 1kg (1.1 ~ 2.2 lbF)	-----

LCM-25KN

Type	Plastic bar	Push terminal 1 (AC/L, AC/N, Push)	Push terminal 2 (Vo+/-, SYN+/-)	KNX bus terminal (BUS V+/-)
Solid wire	-----	-----	-----	0.6 ~ 0.8Φ
Stranded wire	-----	0.326 - 3.31mm ²	0.52 ~ 2.08mm ²	-----
American wire gauge	-----	12 ~ 22AWG	14 ~ 20AWG	20 ~ 22AWG
Wire stripping length	-----	7mm (0.27")	7mm (0.27")	5mm (0.196")
Screwdriver	6mm Phillips	3mm Phillips	3mm Phillips	-----
Recommended tightening torque	3.5 kfg-cm(3 lb-in)	-----	-----	-----
Suggested push-down strength	-----	3~4kg(6.661~8.81 lbF)	2.5~3.5kg(5.51~7.71 lbF)	-----

1.6 Information at the ETS-Software

Selection at the product database:

Manufacturer: MEANWELL Enterprises Co.Ltd.

Product family: Output.

Product type: KLD

Product name: addicted to the used type, e.g.: LCM-40KN, LED Driver with KNX interface

Order number: addicted to the used type, e.g.: LCM-40KN

1.7 Starting up

After wiring, the allocation of the physical address and the parameterization of every channel follow:

- (1) Connect the interface with the bus, e.g. MEANWELL USB interface KSI-01U.
- (2) Switching the power supply.
- (3) Set bus power up.
- (4) Press the programming button at the device (red programming LED lights).
- (5) Loading of the physical address out of the ETS-Software by using the interface (red LED goes out, as well this process was completed successful).
- (6) Loading of the application, with requested parameterization.
- (7) If the device is enabled you can test the requested functions (also possible by using the ETS-Software).

2. Communication Objects

2.1 Summary and Usage

Num	Object Function	Length	DPT	Flag	Function Area	Description
Central Objects:						
1	Operation	1 bit	State (DPT 1.011)	CRT	Central Function	This Communication is shown permanently and can be used to send status of the device to the system at regular intervals when active.
2	Switch On/Off	1 bit	Switch (DPT 1.001)	CW	Normal dimmer	This Communication Object is for controlling the main function Switch On/Off and normally connected to all desired control keys.
3	Switch State	1 bit	State (DPT 1.011)	CRT	Normal dimmer/ Staircase ligh	This Communication is shown permanently and can be used for showing the switching state On/Off of the device.
4	Dim relatively	4 bit	Dimming control (DPT 3.007)	CW	Normal dimmer	This Communication is shown permanently and allows the controlling of the main function Dim Absolutely for the device.
5	Dim absolutely	1 byte	Percentage (DPT 5.001)	CW	Normal dimmer	This Communication Object is for controlling the main function Dim absolutely for this device, which is normally connected to all desired control keys.
6	State Dimm Value	1 byte	Percentage (DPT 5.001)	CRT	Normal dimmer/ Staircase light	This Communication Object is for showing dimming value of this device. NOTE: This value will no be affected by CLO
7	Scene	1 byte	Scene number (DPT 17.001)	CW	Normal dimmer	This Communication Object is only shown after activating in the parameter settings and can be used for calling scenes.
			Scene control (DPT 18.001)			This Communication Object is only shown after activating in the parameter settings and can be used for calling scenes and learning a new scene.
8	Automatic 1	1 bit	Switch (DPT 1.001)	CW	Normal dimmer	This Communication Object is only shown after activating in the parameter settings and can be used for calling of absolute brightness values with a 1 Bit command.
9	Automatic 2	1 bit	Switch (DPT 1.001)	CW	Normal dimmer	This Communication Object is only shown after activating in the parameter settings and can be used for calling of absolute brightness values with a 1 Bit command.
10	Automatic 3	1 bit	Switch (DPT 1.001)	CW	Normal dimmer	This Communication Object is only shown after activating in the parameter settings and can be used for calling of absolute brightness values with a 1 Bit command.
11	Automatic 4	1 bit	Switch (DPT 1.001)	CW	Normal dimmer	This Communication Object is only shown after activating in the parameter settings and can be used for calling of absolute brightness values with a 1 Bit command.
12	Block I	1 bit	Enable (DPT 1.003)	CW	Normal dimmer/ Staircase light	This Communication is shown permanently and can be used for blocking this device.
13	Block II	1 bit	Enable (DPT 1.003)	CW	Normal dimmer/ Staircase light	This Communication Object is shown permanently and can be used for an extended blocking function.

14	Staircase light	1 bit	Switch (DPT 1.001)	CW	Staircase light	This Communication Object is only shown when Staircase light is active and can be used to switch the staircase function on.
15	Staircase light with time	2 byte	time(0-65535)s (DPT 7.005)	CW	Staircase light	This Communication Object is only shown when Staircase light is active and can be used to switch the staircase function on with a certain delay.
16	Prewarning	1 bit	Alarm (DPT 1.005)	CRT	Staircase light	This Communication Object is only shown when Staircase light is active and can be used to show status of Prewarning. The object will send a signal when Staircase light enters the period of prewanning and it will send out a signal again when prewarning finished.
17	Permanent ON	1 bit	Switch (DPT 1.001)	CW	Staircase light	This Communication Object is only shown when Staircase light is active and can be used to switch the staircase light permanently on.
18	Short circuit on load	1 bit	Alarm (DPT 1.005)	CRT	Normal dimmer/ Staircase light	This Communication Object is only shown when Enable LED driver output error detect is active and can be used to show whether there is a short circuit on load
19	Block of push dimming	1 bit	Enable (DPT 1.003)	CW	push dim	This Communication Object is only shown when push dim port is active and can be used for blocking push dim function
20	Switch of push dimming	1 bit	Switch (DPT 1.001)	CRT	push dim	This Communication Object is only shown when push dim port is active and can be used to send switching signals to the system
21	Dim up/down of push dimming	4 bit	Dimming control (DPT 3.007)	CRT	push dim	This Communication Object is only shown when push dim port is active and can be used to send dimming signals to the system
22	AC input status	1 bit	Alarm (DPT 1.005)	CRT	AC monitor	This Communication Object is only shown when AC monitor in Function of push dim port is active and can be used to send out AC status of the device
23	Operating hours (Counter,in seconds)	4 Bytes	Time lag(s) (DPT 13.100)	CRT	Operating hours	This Communication Object is only shown when Counting of operating hours & CLO is active and can be used to send out the operating time of the device
	Counter pulse (DPT 12.001)		This Communication Object is only shown when Counting of operating hours & CLO is active and can be used to send out the operating time of the device			
24	Operating hours (set value, in seconds)	4 Bytes	Time lag(s) (DPT 13.100)	CW	Operating hours	This Communication Object is only shown when Counting of operating hours & CLO is active and can be used to overwrite the operating time the device counted
	Operating hours (set value, in seconds)		Counter pulse (DPT 12.001)			This Communication Object is only shown when Counting of operating hours & CLO is active and can be used to overwrite the operating time the device counted
25	Watts report	4 Bytes	Power (DPT 14.056)	CRT	Central function	This Communication Object is only shown when Power consumption feedback is active and can be used to report out power of the device

3.Reference ETS-Parameter

3.1 General function

Startup timeout(Bus)	2 s
Send "operation" cyclic(0=not active)	0 min

The chart shows the dynamic range for this parameter:

ETS -text	Dynamic range [default value]	Comment
Startup timeout	2 -60s [2s]	All functions run after startup timeout finished. NOTE: The timeout starts counting when power-on initialization is done. So it always takes longer than you expected
Send "Operation" cyclic (0=not active)	0 - 30,000min [0]	Sends status signals from the object Operation at intervals you desire

The following chart shows the objects that belong to general setting:

Number	Name	Length	Usage
1	Operation	1 bit	Sends status of the device to the system at regular intervals when active

3.2 Handling/ basic functions

The basic functions of the dimming actuator are divided in three sections: Switching, dimming relatively and dimming absolutely. As soon as a channel is activated, the communication functions for the basic functions are standardly shown.

3.2.1 Switching

A channel can be switched on or off by the switching command. In addition, there is a state object, which shows the actual switching state of the output. This object, State On/Off, can be used for visualization. When the actuator shall be switched by a binary input or a push button, this object must be connected with the state object of the binary input or the push button for toggling.

Number	Name	Length	Usage
2	Switch On/Off	1 bit	Switches 1 Bit switches the channel on or off
3	State On/Off	1 bit	Shows the switching state of the channel

3.2.2 Dim relatively

The relative dimming allows continuous dimming. So the lights can be dimmed evenly from 0%(10%) to 100% or from 100% to minimum light. The relative dimming process can be stopped at every state. The behavior of the dimming process can be adjusted via additional parameters, Increase: 1%/3%/6%/12%/25%/50%/100%/break ; Derease: 1%/3%/6%/12%/25%/50%/100%/break

Number	Name	Length	Usage
4	Dim relatively	4 bit	Dims the channel continuous up and down

3.2.3 Dim absolutely

A discrete brightness level can be set by the absolute dimming process. By sending an absolute percent value to the 1 Byte object "Dim absolutely", the output assumes a certain brightness level.

Number	Name	Length	Usage
5	Dim absolutely	1 byte	Adjusts a certain brightness level

3.3 Time function

The dimming actuator has the opportunities of connecting different time functions. Besides the normal on/off delay, an additional staircase function with different sub functions is available.

3.3.1 On/ Off delay

The on and off delay allows a delayed switching. The following chart shows this parameter:

On delay	<input type="text" value="0"/>	s
Off delay	<input type="text" value="0"/>	s

The chart shows the dynamic range for this parameter:

ETS-text	Dynamic range [default value]	Comment
On delay/ Off delay	0s – 30,000s [0s]	Adjustment of the time at which the switch on/switch off process shall be delayed

By using the On delay and Off delay, switching commands can be delayed. The delay can affect only to the rising edge (switch on delay) or the falling edge (switch off delay). Furthermore, both functions can be combined. The following diagram shows the functional principle of both functions, which are activated in this example:

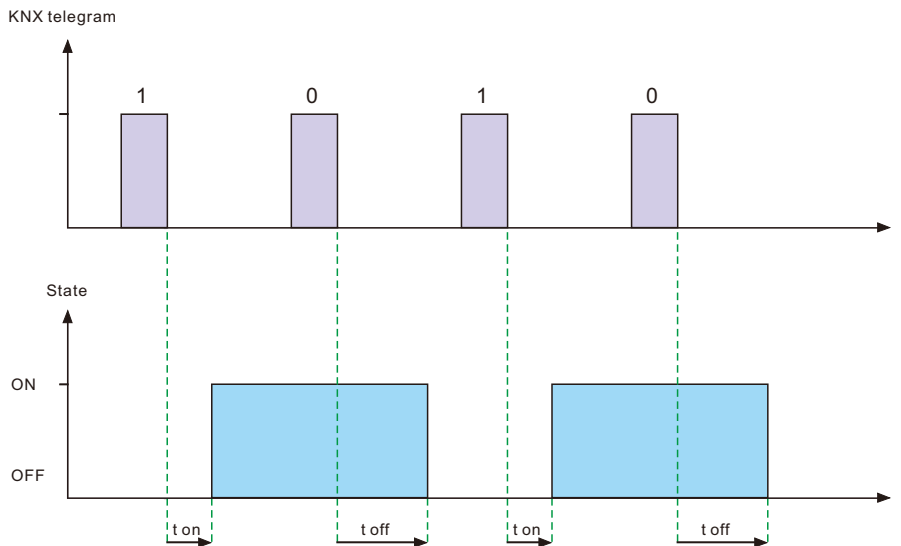

3.4 Staircase light

Staircase light allows an automatic off-switching of the channel, when the adjusted time runs out. To parameterize this function, the staircase light must be activated at the corresponding channel:

Staircase light	<input checked="" type="radio"/> not active <input type="radio"/> active
-----------------	--

If the staircase light is activated, the corresponding functions are shown at the same menu and the further parameterization can be done.

Duration for staircase light	<input type="text" value="90"/>	s
Prewarning	<input checked="" type="radio"/> not active <input type="radio"/> active	
Extension	<input checked="" type="radio"/> not active <input type="radio"/> active	
Manual switching off	<input checked="" type="radio"/> not active <input type="radio"/> active	
Brightness value during permanent ON	<input type="text" value="50%"/>	
When permanent OFF	<input checked="" type="radio"/> Dimm down off <input type="radio"/> Start time of staircase light	

The chart shows the dynamic range for this parameter:

ETS-text	Dynamic range [default value]	Comment
Duration of staircase light	1s -30,000s [90s]	Duration of the switching process.
Prewarning	• active • not active	Activates the prewarning.
Prewarning duration in [s]	1-30,000 [10s]	Is only shown, when the prewarning is activated.
Value of dimming down	1-100% [20%]	Is only shown, when the prewarning is activated Value of which the channel shall be dimmed down, when the staircase time ran out .
Extension	• active • not active	Activation of a possible extension of the staircase light .
Manual switching off	• active • not active	Activation of Deactivation of the staircase light, before the whole time ran out .
Brightness value during permanent ON	0%(OFF)-100% [50%]	Dimming value at "Permanent ON" mode. Tirggered when the object Permanent ON is "1".
When permanent OFF	• Dim down off • Start time of staircase light	Tirggered after the the object Permanent ON is "0". The channel turns off when the parameter is Dim down off; the channel continues a new staircase light when set at Start time of staircase light.

The duration of the staircase light indicates how long the channel shall be switched on after an ON-signal. After lapse of time, the channel is switched off automatically. Via the parameter "Extension"/ "Manual switching off", the staircase function can be modified. The "Manual switching off" allows switching off the channel before the time ran out. The "Extension" allows an extension of the staircase time, by sending another on telegram, so the time is restarted. The prewarning function creates a dimming down of the lights after expiration of the staircase time. So the lights are still switched on, but with another value. The lights stay at this position for the duration of the prewarning. If the staircase function is activated, the communication object "Switch" is replaced by the communication object "Staircaselight":

Number	Name	Length	Usage
14	Staircaselight	1 bit	switches the staircase function on

The staircase function has no influence to the relative or absolute dimming.

At the following diagram, the staircase function is shown, with an activated deactivation and extension.

The prewarning is activated with a dim down value of 20%:

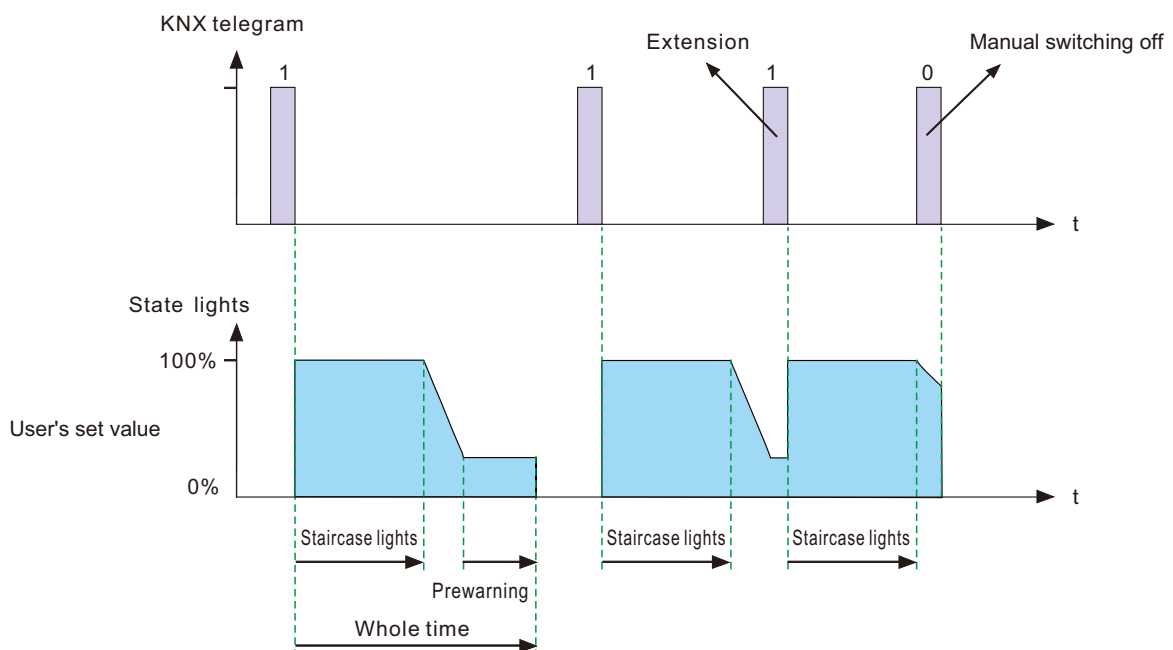

3.5 Push dim port

Push dimming or switch dimming is a dimming method using a simple retractive switch to realize dimming function. Normally a short press of the switch turns the driver on/off, while a long push dims the brightness of light, the dimming direction changes with each long press.

Function of push dim port	push dim
Debounce time	60ms
LED Driver under control by PUSH DIM	<input type="radio"/> not active <input checked="" type="radio"/> active
Blocking object for push dim	<input checked="" type="radio"/> not active <input type="radio"/> active
Function dimming	<input checked="" type="radio"/> Dimming and switching <input type="radio"/> Only dimming
Long operation after	0.6s
On short operation:switch	TOGGLE
On long operation:dimming direction	alternating
Dimming mode	<input checked="" type="radio"/> START/STOP dimming <input type="radio"/> Dimming steps

The chart shows the dynamic range for this parameter:

ETS- text	Dynamic range [default value]	Comment
Function of push dim port	<ul style="list-style-type: none"> • not active • push dim • AC monitor 	Chooses which function to activate. <u>Push dim</u> : push dimming function <u>AC monitor</u> : AC input detection
Debounce time	40ms, 60ms, 80ms, 100ms [60ms]	Sets a delay time for reaction to prevent signal debounce
When "push dim" is selected in "Function of push dim port", the parameters below appear		
Led Driver under control by PUSH DIM	<ul style="list-style-type: none"> • not active • active 	<u>not active</u> : The driver is not controlled by the PUSH DIM function, but is used as a KNX switch component to provide push dimming signals for other KNX devices. <u>active</u> : Actions of the driver is synchronized with PUSH DIM signals NOTE: If Staircase light function is enabled, only switch on/off can be controlled here.
Blocking object for push dim	<ul style="list-style-type: none"> • not active • active 	Activates object of Blocking of push dimming
Function dimming	<ul style="list-style-type: none"> • Dimming and switching • Only dimming 	Chooses whether push dim is with switch on/off function or not
Long operation after	0.3s, 0.4s, 0.5s, 0.6s, 0.8s, 1.0s, 1.2s, 1.5s, 2s, 3s, 4s, 5s, 6s, 7s, 8s, 9s, 10s [0.6s]	By how long to push the driver to recognize as a long press signal
On short operation: switch	<ul style="list-style-type: none"> • ON • OFF • TOGGLE • no reaction 	How to react when the driver received a short press signal
On long operation: dimming direction	<ul style="list-style-type: none"> • BRIGHTER • DARKER • alternating 	Chooses dimming direction for a long press signal
On operation: dimming direction	<ul style="list-style-type: none"> • BRIGHTER • DARKER • alternating 	Chooses dimming direction

ETS- text	Dynamic range [default value]	Comment
Dimming mode	<ul style="list-style-type: none"> • START/STOP dimming • Dimming steps 	START/STOP dimming process starts with a telegram BRIGHTER or DARKER to increase or decrease light intensity and ends with a STOP telegram
Brightness change on every sent telegram	100%, 50%, 25%, 12%, 6%, 3%, 1% [3%]	Parameterizes a desired dimming step
Telegram is repeated every in s	0.3s, 0.4s, 0.5s, 0.6s, 0.8s, 1.0s, 1.2s, 1.5s, 2s, 3s, 4s, 5s, 6s, 7s, 8s, 9s, 10s [0.6s]	Parameterizes a desired dimming cycle
When "AC monitor" is selected in "Function of push dim port", the parameters below appear		
When AC input failure, Led driver	<ul style="list-style-type: none"> • no reaction • send out warning message 	How to react when there is no AC input for the driver
If backup DC input, dimming output (Not for Staircase light)	<ul style="list-style-type: none"> • no change • light value 	How to react when there is backup DC input detected
light value	Off, 10% light, 20% light, 100% light [50% light]	Choose a light value when backup DC input is detected

The following chart shows the objects for this parameter:

Number	Name	Length	Usage
19	Block of push dimming	1 bit	Activation/Deactivation of blocking Process for push dimming
20	Switch of push dimming	1 bit	Sends out switching on/off signals to the system every short push
21	Dim up/down of push dimming	4 bits	Sends out dimming signals to the system while dimming Bit3=1 is dimming up; Bit3=0 is dimming down; Bit2-bit0=000 is dimming step = STOP Bit2-bit0=001 is dimming step = 100% Bit2-bit0=010 is dimming step = 50% Bit2-bit0=011 is dimming step = 25% Bit2-bit0=100 is dimming step = 12% Bit2-bit0=101 is dimming step = 6% Bit2-bit0=110 is dimming step = 3% Bit2-bit0=111 is dimming step = 1%
22	AC input status	1 bit	Used to send out an alarm signal when there is no AC input. Only appears when AC monitor is selected

3.6 Operating hours & Constant light output (CLO)

Luminous flux of LEDs reduces over time as the diodes age, Constant Light Output (CLO) function is utilized to continuously compensate for the drop in luminous flux of the luminaire. This compensation is automatic, requiring no maintenance resource and the installation does not need to be over installed to compensate for future light depreciation from the diodes. You also can receive data of how long the luminaire has been operating to organize a replacement before the end of LEDs' service life.

Counting of operating hours & CLO not active active

3.6.1 Operating hours

Operating hours can be used to monitor service time of the luminaire and used to prepare a replacement before the lamp is over its lifetime so as to maintain a constant level of illumination for the building.

Counting of operating hours in	<input type="radio"/> hours <input checked="" type="radio"/> seconds
Send counters on change(per hour)	<input type="radio"/> not active <input checked="" type="radio"/> active
Send counters cyclically	not active <input type="text"/>
Constant light output(CLO)	<input checked="" type="radio"/> not active <input type="radio"/> active

The chart shows the dynamic range for this parameter:

ETS- text	Dynamic range [default value]	Comment
Counting of operating hours in	• Hours • Seconds	Choose what unit is used in record
Send counters on change(per hour)	• not active • active	Sends out the operating time every hour when active
Send counters cyclically	10min, 20min, 30min, 40min, 50min, 60min, not active [not active]	Sends out the operating time at intervals you desire
Constant light output(CLO)	• not active • active	Activates the CLO function

The following chart shows the objects for this parameter:

Number	Name	Length	Usage
23	Operating hours(Counter, in seconds/ hours)	4 bytes	Sends the operating time of the driver counted to the system at regular intervals when active. Unit: seconds or hours
24	Operating hours(set value, in seconds/hours)	4 bytes	Overwrites the operating time the driver counted. Used to reset the timer when replacing new LEDs. Unit: seconds or hours

NOTE:

The LCM-KN saves the up-to-date operating time information into its MCU flash memory every 10 mins. If there is bus voltage failure that occurs, the driver will lose the up to date operating time. In case the bus voltage is back to normal, the operating time data is fetched from its flash memory.

For example 1, LCM is already operating for 300 minutes. After 9 minutes, the bus voltage is lost and back to normal, the operating time acquired from LCM internal flash is then 300 minutes.

For example 2, LCM is already operating for 300 minutes. After 11 minutes, the bus voltage is lost and back to normal, the operating time acquired from LCM internal flash is then 310 minutes.

3.6.2 Constant light output (CLO)

Lumen depreciation is the luminous flux lost over time and it is irreversible. Generally, luminous flux of lamps without CLO decreases to 80% from 100% after 50,000 hours. In contrast to lamps with CLO, albeit luminous flux starts at 80%, it can be still maintained at around 80% even the lamps have been servicing for the same period of 50,000 hours. The method of CLO is that the luminaire starts its service life at a lower operational current and the current gradually increases over its service life to compensate for the LED's light depreciation.

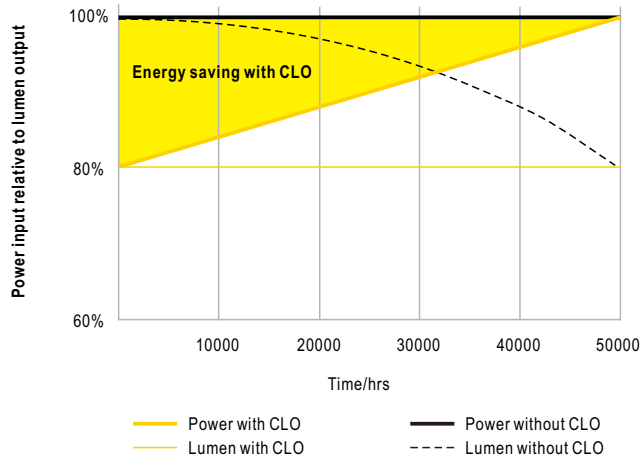

	LED module work time before(x100 hours)	CLO factor
Scheduled division 1	100	80%
Scheduled division 2	150	85%
Scheduled division 3	200	90%
Scheduled division 4	300	95%
Scheduled division 5		100%

The chart shows the dynamic range for this parameter:

ETS- text	Dynamic range [default value]		Comment
Scheduled division 1	1(x100hours) - 500(x100hours) [100(x100hours)]	10% - 100% [80%]	Parameterizes the first stage of CLO
Scheduled division 2	1(x100hours) - 500(x100hours) [150(x100hours)]	10% - 100% [85%]	Parameterizes the 2nd stage of CLO
Scheduled division 3	1(x100hours) - 500(x100hours) [200(x100hours)]	10% - 100% [90%]	Parameterizes the 3rd stage of CLO
Scheduled division 4	1(x100hours) - 500(x100hours) [300(x100hours)]	10% - 100% [95%]	Parameterizes the 4th stage of CLO
Scheduled division 5		10% - 100% [100%]	Parameterizes the final stage of CLO

3.7 Absolute Values

The dimming area of the dimming actuator can be restricted by absolute values. Furthermore absolute or saved values can be called, when the actuator is switched on.

3.7.1 Starting behavior

The function "Starting behavior" defines the turn on behavior of the channel. The function can be parameterized for every channel individually.

Starting behavior

On-value setting
 Last light value (Memory)

Value of switch startup behavior:

The chart shows the dynamic range for this parameter:

ETS-text	Dynamic range [default value]	Comment
On-value setting	Sub-function: Value of switch startup behavior 6-100% [50%]	If this sub-function is chosen, a new sub-function is shown, at which an absolute value for switching on can be chosen
Last light value (Memory)		The channel starts with the last value before switching off

Via the parameter "Value of start up", an absolute value for switching on can be assigned to the channel. The value for startup contains the whole technical possible area, so from 1-100%. But if the dimming area is restricted, the dimming actuator will be at least switched on with the lowest allowed value and maximum with the highest allowed value; independent from the chosen Value of startup.

The parameter "Last light value", also called memory function, causes a switching on of the actuator with the value before the last switching off. So the actuator saves the last value. If, for example, the channel is dimmed to 50% and switched off by switch object afterwards, the channel will be switched on with 50% again.

3.7.2 Dimming area

Via the parameters "maximum light" and "minimum light", the dimming area can be restricted.

Maximum light	100%
Minimum light	6%

The chart shows the dynamic range for this parameter:

ETS-text	Dynamic range [default value]	Comment
Maximum light	7-100% [100%]	Highest, maximum allowed light value
Minimum light	6-99% [6%]	Lowest, minimum allowed light value

If the technical possible dimming area (6-100%) shall be restricted to a lower area, you have to set values for the minimum light above 6% and for the maximum light under 100%. This restriction of the dimming area is possible for every channel. If the dimming area is restricted, the channel will only move in the adjusted restriction. This setting has also effects to the other parameter: If, for example, the channel is restricted to a maximum of 85% and the value of startup is chosen as 100%, the channel will switch on with the maximum of 85%. An excess of the maximum value is no longer possible. The restriction of a dimming area is useful when certain values must not be reached, because of technical reasons, for example preservation of the life span or the avoidance of flickering at lower dim values (especially at Energy saver).

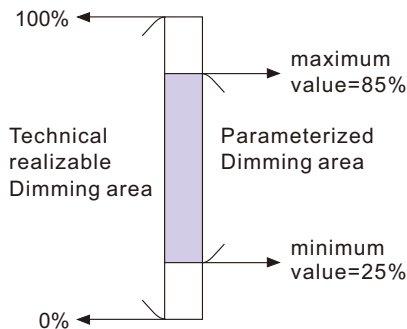

Example: Minimum light = 25%, maximum light = 85%, Value for startup= 100%

- On telegram → adjusted light value 85%
- 50% telegram → adjusted light value 50%
- 95% telegram → adjusted light value 85%
- 15% telegram → adjusted light value 25%
- Off telegram → adjusted light value 0% (Off)

3.8 Specific Dimming settings

The dimming behavior and Soft-Start/Stop can be adapted individually via the functions below.

Dim speed for relative dimming	1	s
Off via relative dimming	<input checked="" type="radio"/> not active <input type="radio"/> active	
ON via relative dimming	<input type="radio"/> not active <input checked="" type="radio"/> active	
Dim speed for absolute dimming(0=Jump)	2	s
On speed	1 s	
Off speed	1 s	

3.8.1 Dimming speed

The dimming speed allows parameterizing the duration of the dimming process individually.

The chart shows the dynamic range for this parameter:

ETS-text	Dynamic range [default value]	Comment
Dimming speed for relative dimming	1-120s [5s]	Defines the time for all relative dim processes related to relative dimming process of 100%. If a time of 10s is adjusted, the relative dimming from 0% to 100% and vice versa would last 10s. So the relative dimming from 0% to 50% would last 5s.
On via relative dimming	<ul style="list-style-type: none"> • not active • active 	To maintain the output at OFF condition or turn on the output when dimming value is greater than the minimum level
Off via relative dimming	<ul style="list-style-type: none"> • not active • active 	To maintain the output at the minimum level or turn off the output when dimming value is lower than the minimum level
On speed	1-240s [2s]	The On Speed realizes a Soft Start function. At an On Speed of 2s, the LED drivers will be dimmed up to 100% in 2s when switching on.
Off speed	1-240s [2s]	The Off Speed realizes a Soft Stop function. Speed of 2s, the LED drivers will be dimmed down to 0% in 2s when switching off.
Dimming speed for absolute dimming (0=Jump)	0-120s [5s]	Defines the time for all absolute dimming processes related to an absolute dimming process of 100%. If a time of 10s is adjusted, the absolute dimming from 0% to 100% and vice versa would last 10s. So the absolute dimming from 0% to 50% would last 5s.

3.8.2 Send dimming value after change

To visualize the dimming value, for example via a display, the following communication object must be activated:

Send dim value after change not active at dim end

ETS-text	Dynamic range [default value]	Comment
Send dim value after change	<ul style="list-style-type: none"> • not active • active 	Activates the status object for the dimming process

The communication object for the actual dimming value is shown continuous, but sends only the actual dimming value, when the parameter "Send dimming value after change" is activated.

Number	Name	Length	Usage
6	State dimm value	1 byte	Sends the actual dimming value in %

3.8.3 Dimming curve

The actuator provides both linear and logarithmic dimming curves for selection. In a linear dimming curve, the signal sent to the drivers is linear, increasing in a steady rate. In contrast to logarithmic - the signal to the drivers changes slower at deeper dimming levels and faster at the brighter end.

Dimming curve Linear Log

ETS-text	Dynamic range [default value]	Comment
Dimming curve	<ul style="list-style-type: none"> • Linear • Log 	Selection of linear or logarithmic dimming signal

3.9 Scene function

When functions of different groups (e.g. light, heating and shutter) shall be changed simultaneously with only one keystroke, it is practical to use the scene function. By calling a scene, you can switch the lights to a specific value, drive the shutter to an absolute position, switch the heating to the day mode and switch the power supply of the sockets on. The telegrams of these functions can have as well different formats as different values with different meaning (e.g. "1" for switch the lights off and open the shutters). If there were no scene function, you would have to send a single telegram for every actuator to get the same function.

The scene function of the switch actuator enables you to connect the channels of the switch actuator to a scene control. For that, you have to assign the value to the appropriated space (scene A-H). It is possible to program up to 8 scenes per switching output. When you activate the scene function at the switching output, a new sub menu for the scenes appears at the left selection menu. There are settings to activate single scenes, set values and scene numbers and switch the learn scene function on/off at this sub menu.

Scenes are activated by receiving their scene numbers at the communication object for the scenes. If the "Learn scene" function of the scenes is activated, the current value of the channel will be saved at the called scene number.

The communication objects of the scenes have always the length of 1 byte.

The following illustration shows the setting options at the ETS-Software for activating the scene function:



The scene function can only be activated for the normal switching mode. If the staircase light function is activated, the scene function cannot be activated for this channel.

The following chart shows the communication object for calling a scene:

Number	Name	Length	Usage
7	Scene	1 byte	Call of the scene

For calling a certain scene, you have to send the value for the scene to the communication object.

The value of the scene number is always one number less than the adjusted scene number. For calling scene 1, you have to send a "0". So the scene numbers have the numbers from 1 to 64, but the values for the scenes only from 0 to 63.

If you want to call scenes by a binary input or another KNX device, you have to set the same number at the calling device as at the receiving device. The calling device, e.g. a binary input, sends automatically the right value for calling the scene.

3.9.1 Submenu scene

If a scene is activated, a new submenu will appear at the left selection menu. At this submenu, the further parameterization can be done. For every channel are up to 8 storage options available. These 8 presets have numbers A-H. One of the 64 scene numbers can be assigned to each scene. The following illustration shows the setting options at the submenu for the scenes (Channel X: Scene) for the scenes A-H:

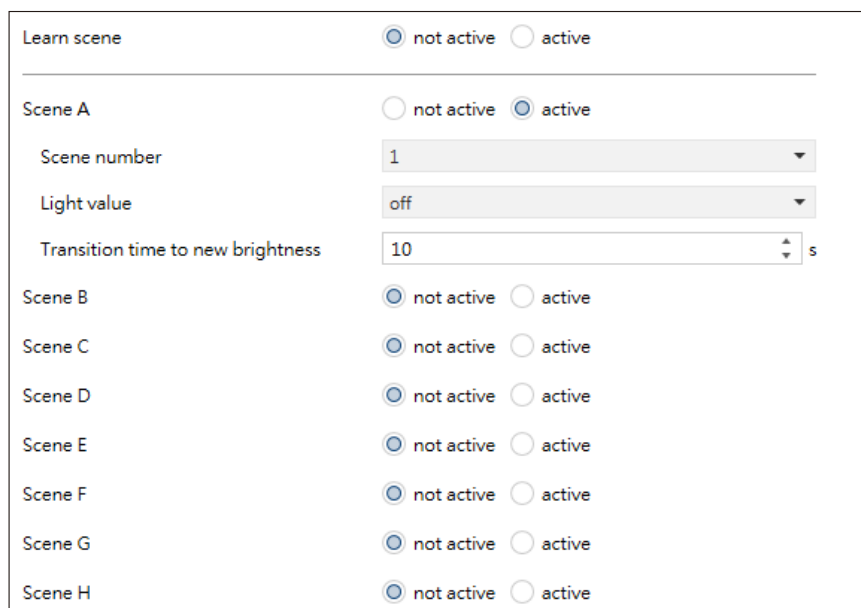

The following chart shows the dynamic range for an activated scene function:

ETS-text	Dynamic range [default value]	Comment
Learn scene	<ul style="list-style-type: none"> • not active • active 	<p>Adjusts whether the learning/saving function shall be enabled for the scenes of this channel or not. For instance: Light value of the Scene A is 20%, this Light value can be adjusted according to user's preference afterwards, say 35%, and the new value is able to be saved via DPT 18.001 scene control by other KNX devices, such as a smart home control panel.</p> <p><u>not active</u>: learn scene function is disabled and object value follows DPT 17.001 scene number.</p> <p><u>active</u>: learn scene function is enabled and object value follows DPT 18.001 scene control.</p>
Scene A-[H]	<ul style="list-style-type: none"> • not active • active 	Activation of the depending scene
Scene Nr. A-[H]	1-64 [A:1; B:2; ... H:8]	Adjusts the number for calling a scene
Light value scene A-[H]	Off, 10%, 20%, 30%, 40%, 50%, 60%,70%, 80%, 90%, 100% light [Off]	Adjusts the light value for a scene call
Transition time to new brightness	1-240s [10]	The time taken from the previous setting to this new scene

At the submenu for the scenes, a reaction can be assigned for the call of each scene. This reaction includes an absolute light value (0-100%) for this channel. Every channel can react to 8 different scenes. By sending of the pick-up value of the relevant scene, the scene is called and the channel adjusts its parameterized values. The individual parameterization is also watched at calling the scene.

If the channel shall dim to 50% at the call of the scene A and the channel has a parameterized switch on delay of 5s, the channel will be switched on after this 5s and be dimmed to the 50% in compliance to the adjusted dimming speed.

To watch at the programming is that if two or more channels shall react to the same scene number, the communication objects for the scenes of these channels have to be connected to the same group address. By sending of the pick-up value for the scenes, all channels will be called. It is practical to divide the group addresses by scenes at the programming. If a channel shall react now to 8 scenes, the communication object has to be connected to 8 different group addresses.

3.10 Automatic function

An automatic function can be activated for every channel. The automatic function allows calling up to 4 absolute exposure values for every channel. Calling can be done via a 1 bit commands.

For further setting options, the automatic function of a channel must be activated.



By activation the automatic function a submenu for further parameterization is shown. Furthermore, the following communication objects are shown:

Number	Name	Length	Usage
8	Automatic 1	1 bit	Calling of the automatic value 1
9	Automatic 2	1 bit	Calling of the automatic value 2
10	Automatic 3	1 bit	Calling of the automatic value 3
11	Automatic 4	1 bit	Calling of the automatic value 4

3.10.1 Submenu automatic function

The further parameterization can be done at the submenu of the automatic function.

Automatic function 1-Exposure value	30% light
Automatic function 2-Exposure value	off
Automatic function 3-Exposure value	off
Automatic function 4-Exposure value	off

ETS-text	Dynamic range [default value]	Comment
Automatic function 1-[4] – Exposure value	Off, 10%, 20%, 30%, 40%, 50%, 60%, 70%, 80%, 90%, 100% light [Off]	Defines the exposure value for an automatic call. Setting only activates when the corresponding object is 1

Every automatic function can be assigned an absolute exposure value (in 10% steps). The call of the automatic function is done by an 1 bit object.

3.11 Block function

Block function can be parameterized for every channel. Via the Block function, the behavior of the channel for calling the blocking objects can be assigned.

Behavior at Block I=value "1"	Light value
Light value	100% light
Behavior at Block I=value "0"	Light value
Light value	10% light
Invert Block I input	<input checked="" type="radio"/> not active <input type="radio"/> active
Release time for Block I (value "1" to "0") (0 min = not active)	0 min
<hr/>	
Behavior at Block II=value "1"	Light value
Light value	100% light
Behavior at Block II=value "0"	Light value
Light value	10% light
Invert Block II input	<input checked="" type="radio"/> not active <input type="radio"/> active
Release time for Block II (value "1" to "0") (0 min = not active)	0 min

3.11.1 Blocking objects

For both blocking objects an action for activation as well as deactivation can be defined

ETS-text	Dynamic range [default value]	Comment
Behavior at Block I = Value 1	Off, no change, Light value (10%,20%,30%,...,100%) [Light value]	Defines the action for activation of the first blocking object
Behavior at Block I = Value 0	Off, no change, Light value (10%,20%,30%,...,100%) [Light value]	Defines the action for deactivation of the first blocking object
InvertBlock I input	• not active • active	If active, inverter singals recived from the Block I Object, that is 1→0; 0→1
Release time for Block I (value "1" to "0") (0 min = not active)	0-600min [0min]	Release the channel from "Behavior at Block I = Value 1" after countdown and enter "Block I = Value 0"
Behavior at Block II = Value 1	Off, no change, Light value (10%,20%,30%,...,100%) [Light value]	Defines the action for activation of the second blocking object
Behavior at Block II = Value 0	Off, no change, Light value (10%,20%,30%,...,100%) [Light value]	Defines the action for activation of the second blocking object
InvertBlock II input	• not active • active	If active, inverter singals recived from the Block II Object, that is 1→0; 0→1
Release time for Block II (value "1" to "0") (0 min = not active)	0-600min [0min]	Release the channel from "Behavior at Block II = Value 1"after countdown and enter "Block II =Value 0"

By using the blocking objects, the channel can be blocked for further usage. Additional, the channel can perform an adjusted function, as dimming to a certain value, switch the channel of or stay in its current state, when it is blocked. The same actions can be performed by the channel, when it is unblocked.

It is important to be aware that the channel cannot be operated when it is blocked. Furthermore the manual usage is blocked during a blocking process. All telegrams, which are sent to the corresponding channel during a blocking process, have no effect for the channel.

If both blocking processes are activated, the first one is of prime importance. But if you activate the second blocking process during the first blocking process, the second blocking process will get active when the first one is deactivated. The action for the deactivation of the first blocking process will not be performed, but the channel calls the adjusted settings for the second blocking process.

Number	Name	Length	Usage
12	Block I	1 bit	Activation/Deactivation of the first blocking process
13	Block II	1 bit	Activation/Deactivation of the second blocking process

Priority from the highest to the lowest is Block I > Block II > Permanent ON > On/Off & Dimming output.

3.12 Other useful information

The driver also provides some useful information including output short-circuit detection and value of power consumption.

Enable LED driver output error detect not active active
 Power consumption feedback not active active

Power consumption feedback not active active
 Setup output watts of LED Driver W
 Send watts report cyclically
 Watts report linked to CLO not active active

The chart shows the dynamic range for this parameter:

ETS-text	Dynamic range [default value]	Comment
Enable led driver output error detect	<ul style="list-style-type: none"> • active • not active 	Activates output short-circuit detection
Power consumption feedback	<ul style="list-style-type: none"> • active • not active 	Sends out total wattage in use
Setup output watts of LED driver	1-60W [60W]	Types actual power wattage of the LED lamp for a power consumption calculation
Send watts report cyclically	not active, 5min, 10min, 15min, ... 55min, 60min [not active]	Sends out a power consumption report at intervals you desire
Watts linked to CLO	<ul style="list-style-type: none"> • not active • active 	There are two ways to report power consumption of the device. No active: send out a value of Setup output watts of LED driver x the current dimming level; Active: send out a value of Setup output watts of LED driver x the current dimming level x the current CLO stage

The chart shows the dynamic range for this parameter

Number	Name	Length	Usage
18	Short circuit on load	1 bit	Sends out signals when there is a short circuit on load. "1"= alarm; "0"= no alarm detected
25	Watts report	4 Bytes	Used to sends out output wattage of the driver, accurate to the one decimal place. Calculation formula is Setup output watts of LED Driver × output level. e.g. setup output watts is 50W and output level is 81% then 40.5W will be reported.

4.Environmental declaration information

https://www.meanwell.com//Upload/PDF/RoHS_PFOS.pdf
https://www.meanwell.com//Upload/PDF/REACH_SVHC.pdf
https://www.meanwell.com//Upload/PDF/Declaration_RoHS-E.pdf

Appendix**A.1 LCM-KN Series Application/Firmware change tracking**

Date	Application Version	Firmware Version	Note
02-April-2019	Rev: 01.0	Rev: 01.1	First release
16-Aug-2019	Rev: 0.10	Rev: 01.2	1) Fix the last light value malfunction. 2) Change the manufacturer ID memory saving method.
24-Mar-2020	Rev: 01.1	Rev: 01.3	1) Fix BCU key issue by stack. 2) Add parameters: On via relative dimming. 3) Add parameters: Watts linked to CLO. 4) Modify catalog information: Lighting /LED driver. Remark: 1. This application database to work with firmware version Rev [3] 1.3(shown in ETS). For firmware Rev [3] 1.2 or previous, the unit will work with this database, but new parameter described above is not available. 2. Please note this database will not work with firmware version Rev[2] 1.2. Click here for how to solve it.

NOTE: For the latest information, please refer to the link below

https://www.meanwell.com//Upload/PDF/KNX_Application%20Database.pdf

明緯企業股份有限公司

MEAN WELL ENTERPRISES CO., LTD.

248 新北市五股區五權三路28號

No.28, Wuquan 3rd Rd., Wugu Dist., New Taipei City 248, Taiwan

Tel: 886-2-2299-6100 Fax: 886-2-2299-6200

<http://www.meanwell.com> E-mail: info@meanwell.com

Your Reliable Power Partner